

The application view

by *Gerrit Muller* University of South-Eastern Norway-NISE

e-mail: `gaudisite@gmail.com`

`www.gaudisite.nl`

Abstract

The purpose of the application view is described. A number of methods or models is given to use in this view: stakeholder and concerns, context diagram, static entity relationship models and dynamic flow models.

Distribution

This article or presentation is written as part of the Gaudí project. The Gaudí project philosophy is to improve by obtaining frequent feedback. Frequent feedback is pursued by an open creation process. This document is published as intermediate or nearly mature version to get feedback. Further distribution is allowed as long as the document remains complete and unchanged.

August 21, 2020
status: preliminary
draft
version: 0.2

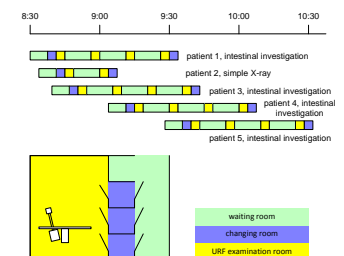

Application view overview

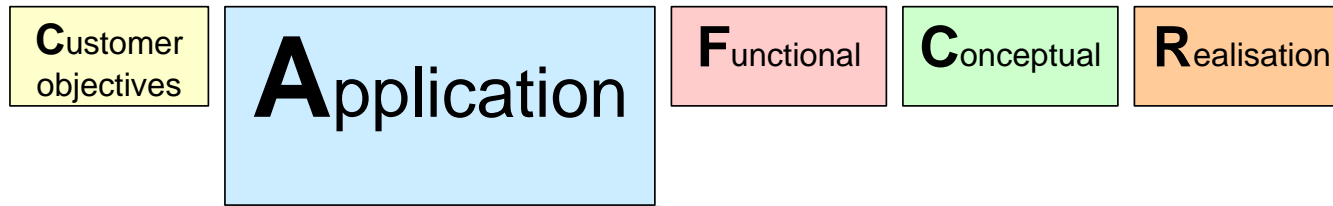

stakeholders and concerns

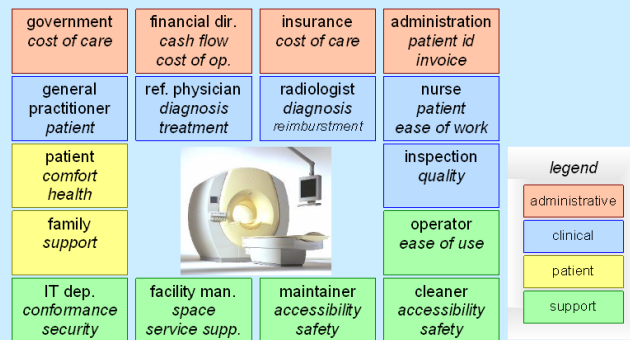

context diagrams

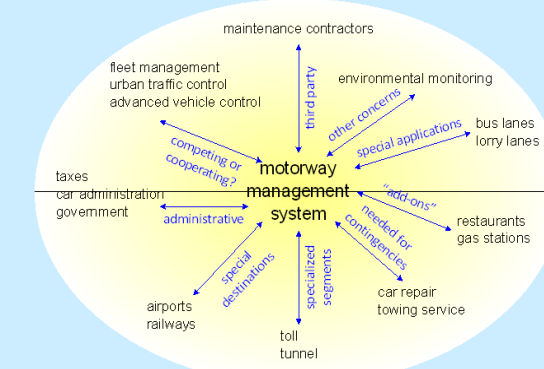

entity relationship models

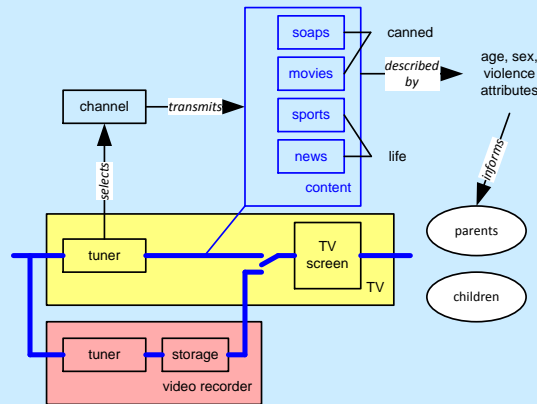

dynamic models

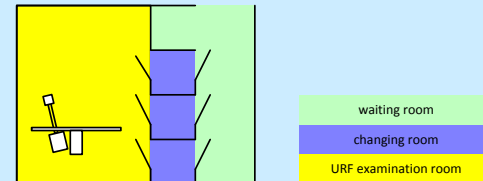
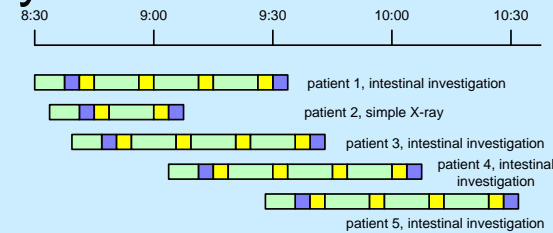

Stakeholders and concerns MRI scanner

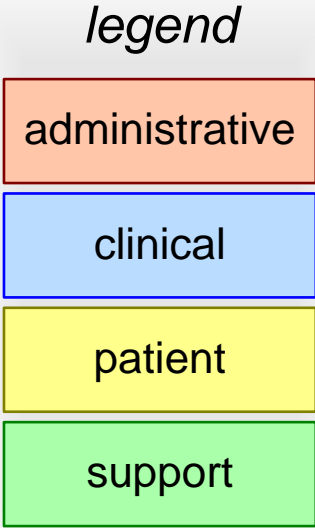
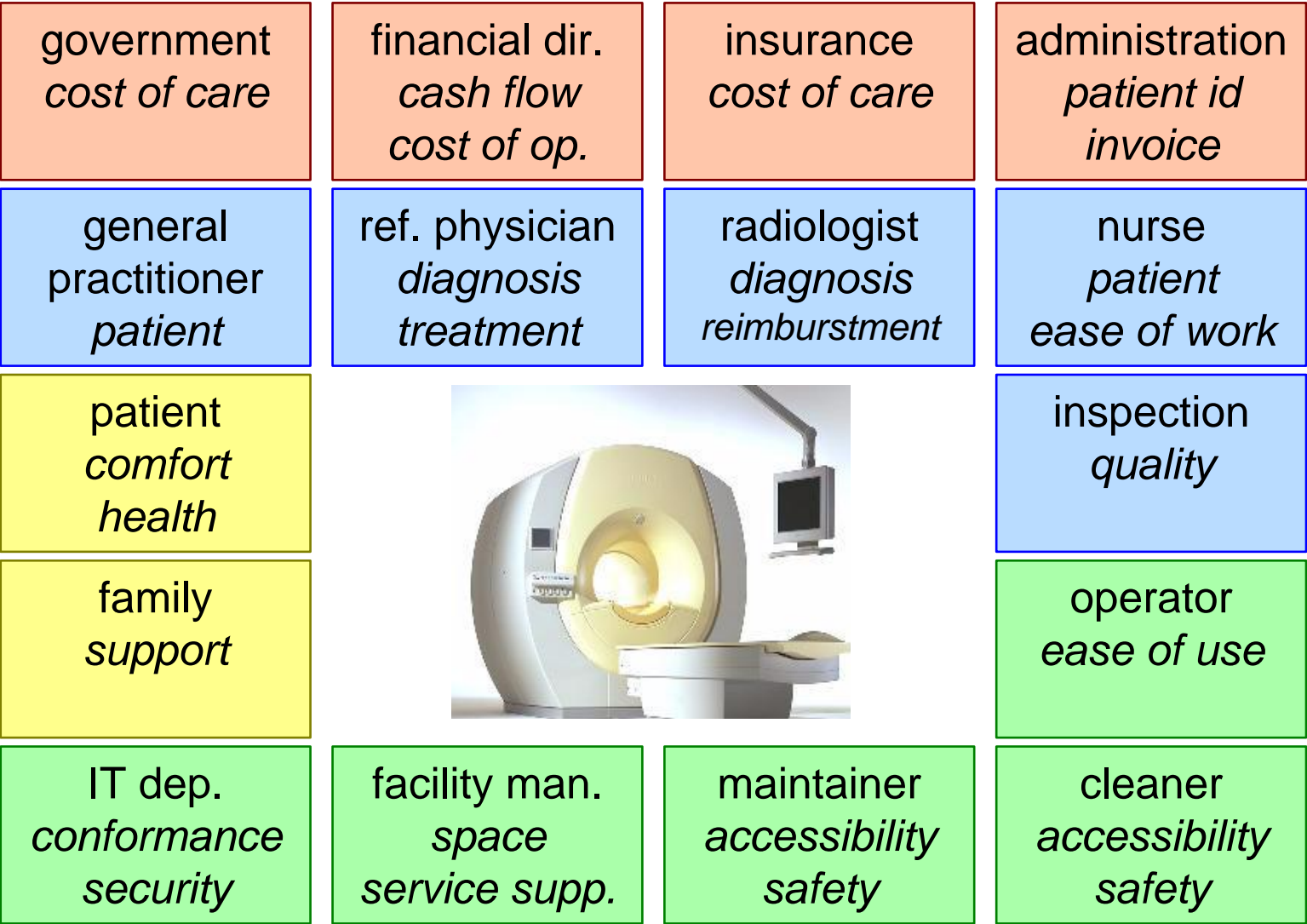

Context of motorway management system

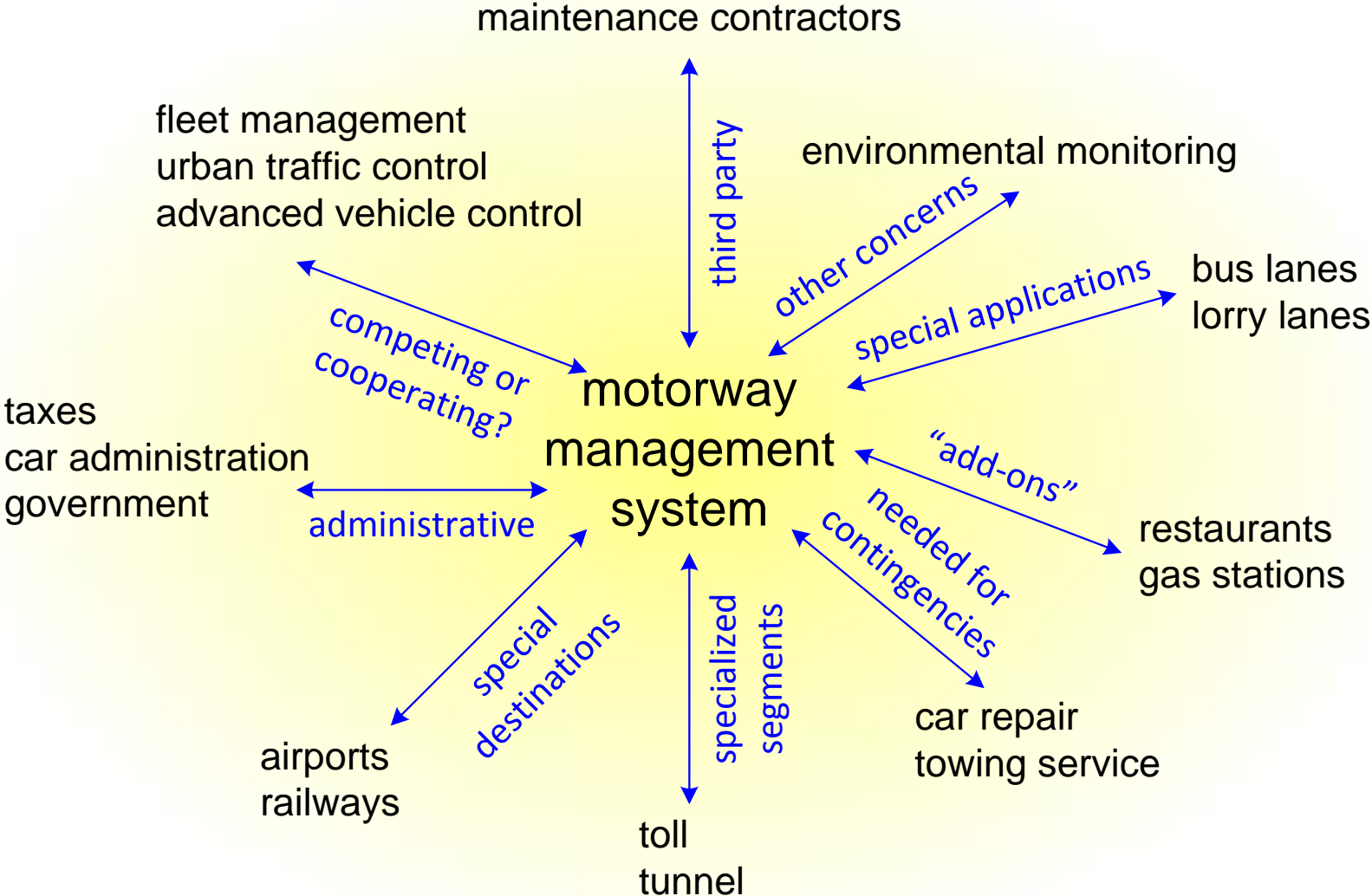

Example of simple TV application model

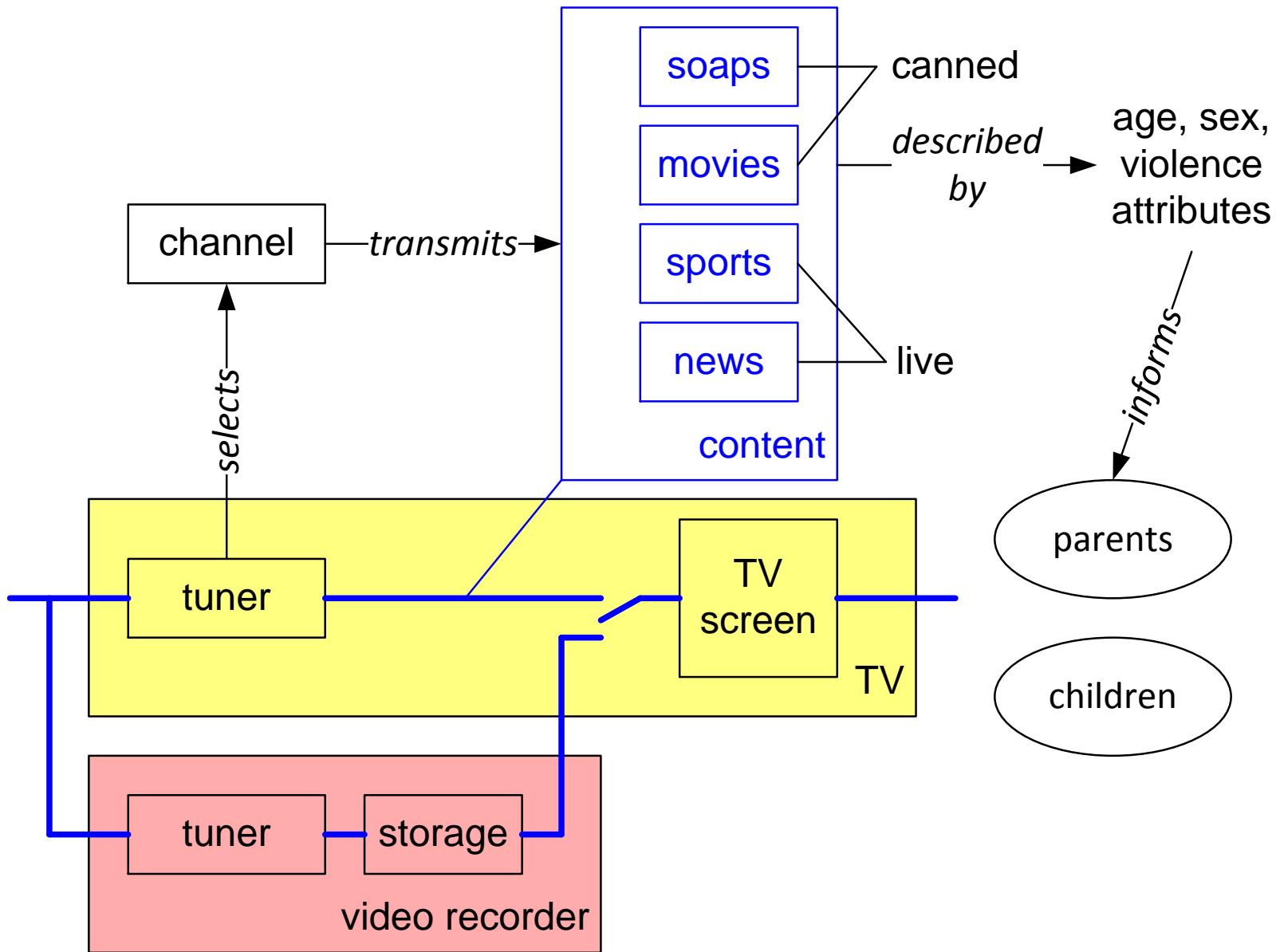

Examples of dynamic models

flow models

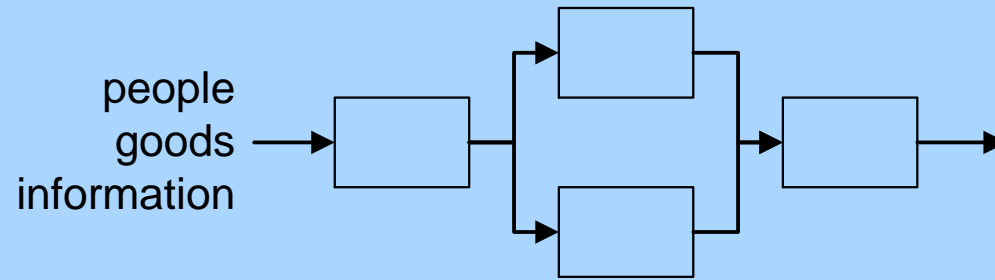

state diagrams

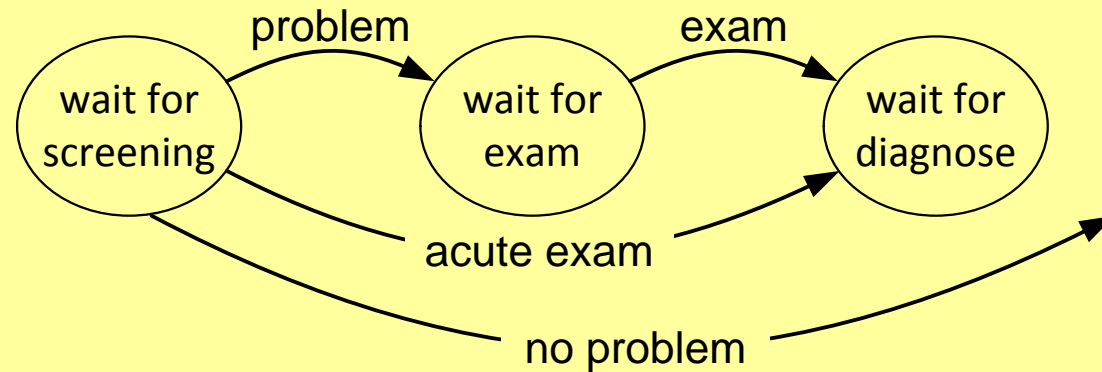

time line



Productivity and Cost models

typical

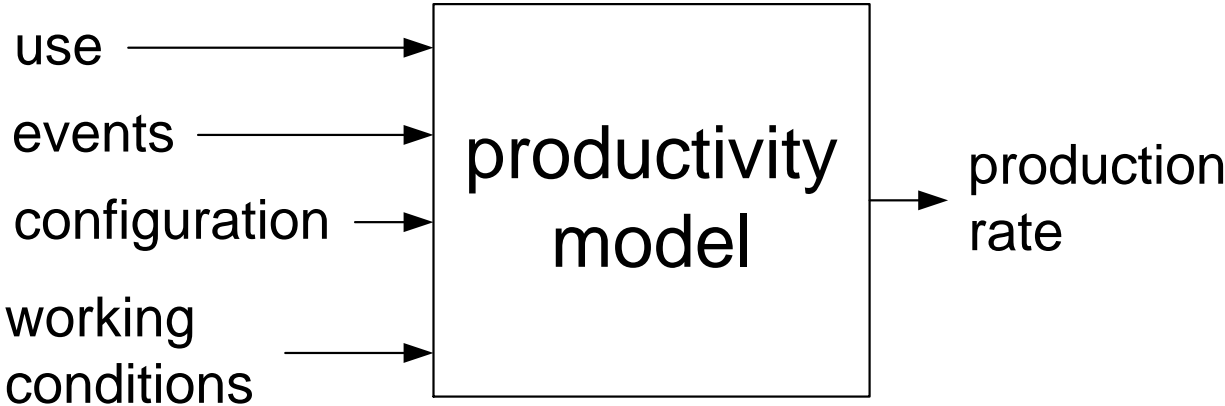

Cost Of Ownership model

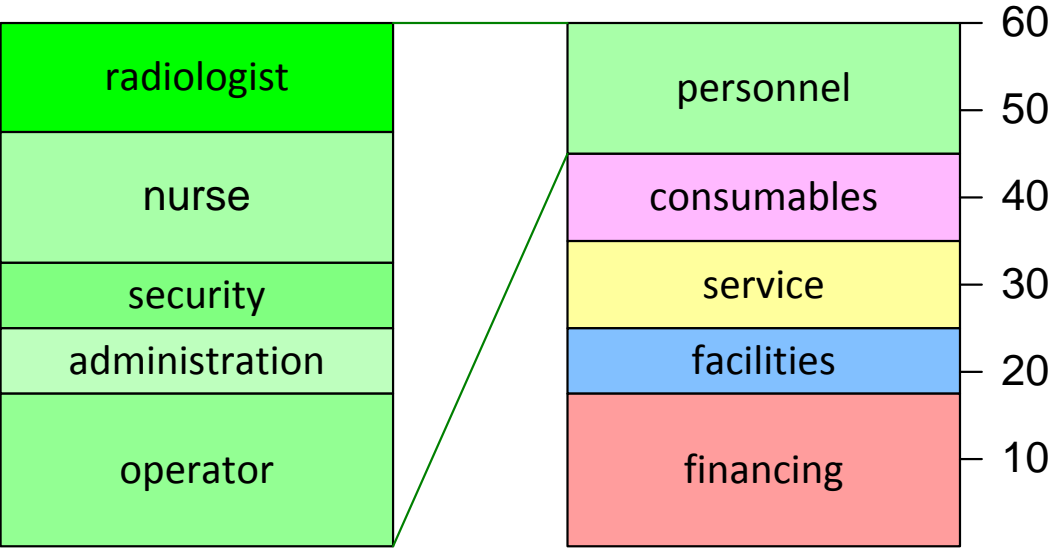

Dynamics of an URF examination room

